

Assembly Instructions  
Sustainability Module /  
Montageanleitung  
Nachhaltigkeitsmodul  
100 cm

Scan this QR code to receive further information about the Beurer Sustainability Module (assembly video, product holders and insert sheets).

Scannen Sie diesen QR Code um weitere Informationen zum Beurer Nachhaltigkeitsmodul zu erhalten (Aufbau-Video, Halterungen und Einschubblätter).



[www.beurer.com/pos](http://www.beurer.com/pos)

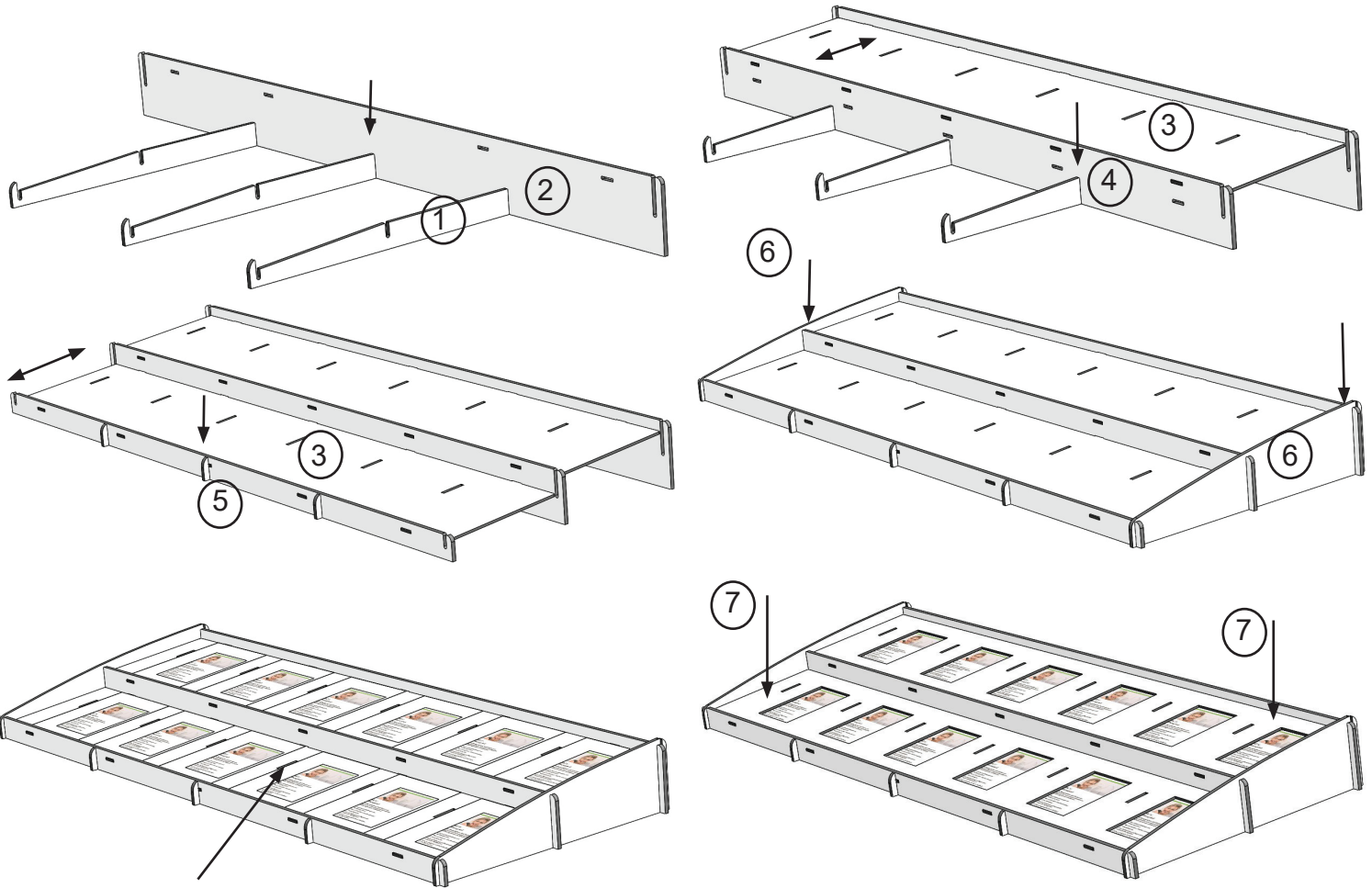

Place the graphic on the slot left aligned /  
Grafik an Schlitz linksbündig anlegen

Beauty 100 cm



Insert backcard /  
Backcard einstecken

Medical 100 cm

